

CRUISE CONTROL SWITCH OPTIONS.

MotorCycle Cruise Controls has three different control switches that can be supplied with the cruise control.

The earlier design has three large buttons and a small indicator light on the end of the switch next to the ON-OFF button. The buttons have text written on them for the functions. This switch will be phased out in late 2020.

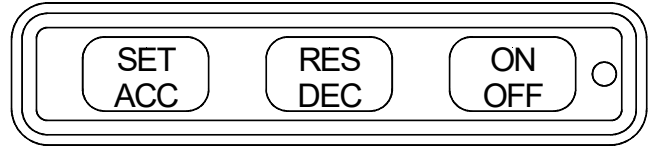

It will be replaced by this switch. The overall size of the switch is the same, it has the same mounting brackets and the same mounting holes. The text has been replaced by pictographs on the buttons. It is a direct replacement for the previous control switch shown above.

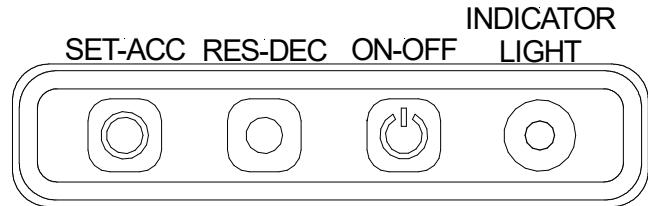

We also have another switch. This design has smaller buttons with no text, only pictographs on the buttons.

The ON-OFF button has a 'standard' power switch pictograph on it.

When it is mounted vertically on the handlebar, as shown here the orientation of the SET and RES buttons is as shown.

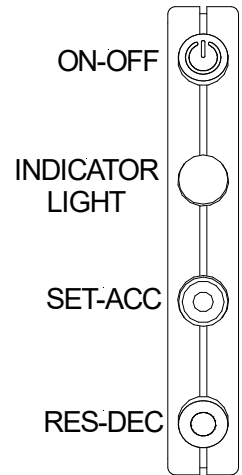

In some cases, this switch is mounted below the bike's switch gear, and is mounted horizontally, the position of the SET and RES button are swapped.

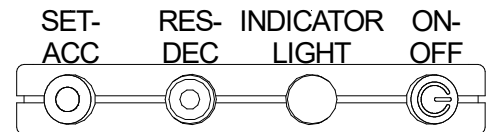

Note: - The control switch has an indicator light next to the ON-OFF button. This light has three colours, RED and GREEN and YELLOW. RED indicates power on. YELLOW indicates cruise control engaged. GREEN is used to confirm the cruise control functions during the diagnostic checks and some calibration procedures.

WARNING

Motorcycle Cruise Controls has five different product ranges based on three different computers (electronics modules or electronics ‘box’).

These products all use the same electrical connector, BUT the wire positions are not compatible.

Under no circumstance should the ‘computer’ from one product be swapped for another without first contacting the manufacturer.

The ‘best’ case if a module is ‘swapped’ is a cruise control that will not work correctly. The most likely result is a ‘blown’ computer that is not repairable. The ‘worst’ case is that this could result in a dangerous situation that may result in injury or death.

**DO NOT UNDER ANY CIRCUMSTANCES
EXCHANGE ONE ‘COMPUTER’ FOR
ANOTHER WITHOUT CONTACTING US
FIRST.**

WARNING

A new, smaller, cruise control computer is now supplied in many of our cruise control kits. This unit is replacing our previous model computer in many cases.

Many of our instruction sets are written and photos taken using our previous model computer. This sheet shows the difference in mounting the cruise control computer and the differences in the wiring connections required.

The parts list in the second or third pages of the installation instruction set will show the part number for 'old' metal box computer as MCSU400C or MCS800.

The new computer part number is MCS8000C.

Functionally, both computers are almost identical, the new unit has some new designs and abilities, and is more compact and lighter. Actual performance of the cruise control is identical, as this is based on the 'firmware' loaded in the computer.

The previous model is the one in the metal 'box' at the rear of this photograph.

The new model is in a black plastic enclosure. This model is quite a bit smaller and lot lighter than the previous model, but still uses the same connector.

WARNING: - The wiring 'pin' positions on the new model are different to the old model and the units are NOT interchangeable without re-wiring the connector.



Mounting the new computer on installations that still show the previous model.

There are several different methods used to mount the previous model computer.

Some installations come with a foam block to mount the cruise control computer.

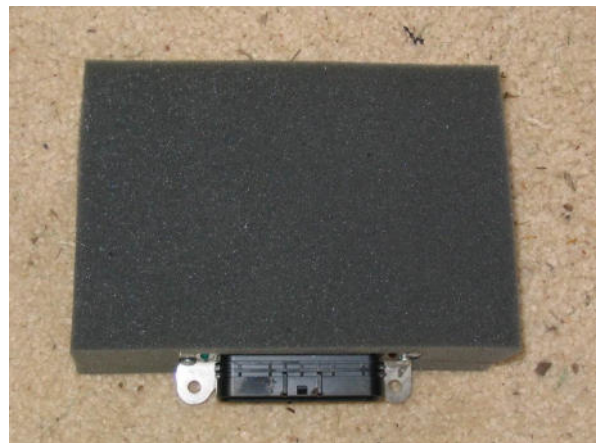

The foam block is then cut to suit the space on the vehicle.

This method can still be used with the new computer.

In some cases, double sided adhesive foam mounting tape will have been supplied.

In most cases Velcro mounting tape will also be provided in the cruise control kit. This may be used instead of the foam block or the foam mounting tape.

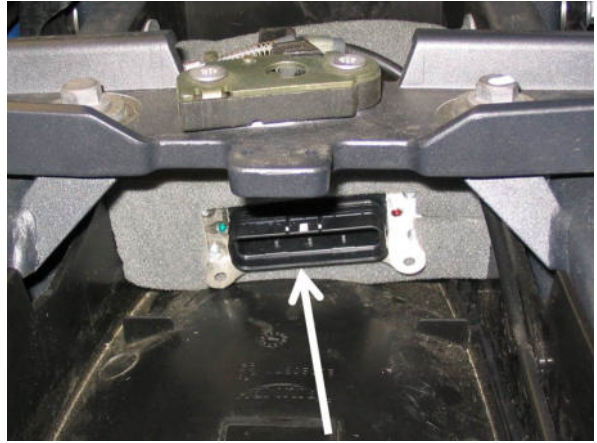

Apply the Velcro tape to the bottom of the computer and use the tape to attach the computer to the vehicle.

This method is also used where a metal mounting bracket is supplied in the kit to mount the computer.



Where a mounting bracket was supplied, the old computer was attached to the bracket using two or four screws.

The new computer is mounted to the bracket using Velcro mounting tape.

After it is attached using the Velcro tape, place a long cable tie (zip tie) around the bracket and the computer 'box' (arrowed).



Changes to wiring pin positions.

In some installations, it is necessary to remove and insert some of the wiring pins in the 'main' cruise control computer plug. The connector is the same for the old and new computers, but the wiring positions (pin-outs) are different.

Take care to ensure that the instruction relate to the correct computer.

In most cases, you will not need this information, the wiring harness supplied is terminated to suit the computer supplied in the cruise control kit.

This diagram below shows the wiring positions for the ‘new’ compact black plastic box computer, Part Number MCS8000C.

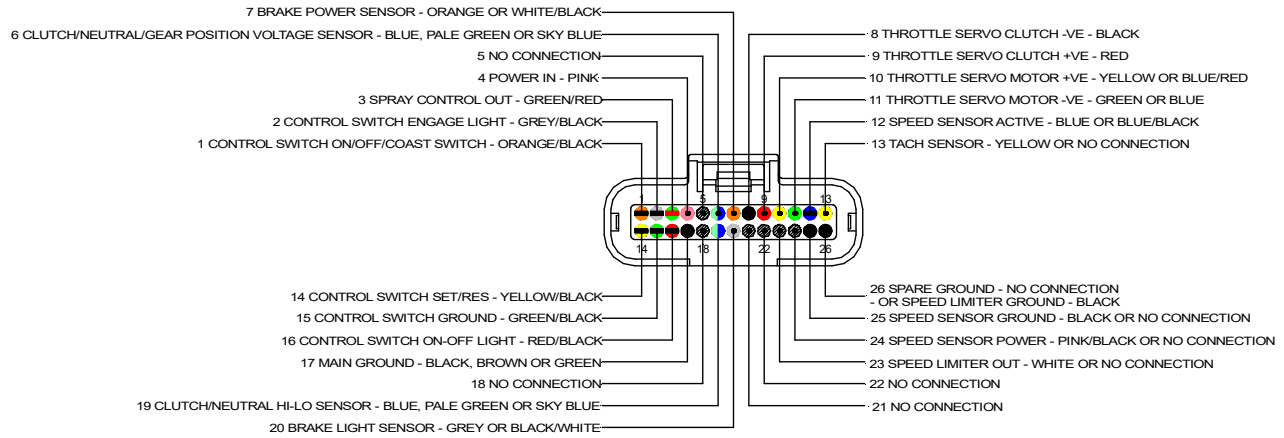

NOTE: - In some cases, position 6 may be used for neutral/clutch sensing instead of position 19

The diagram below shows the wiring positions for the ‘old’ larger metal box computer Part Number MCS800 or MCSU400C.

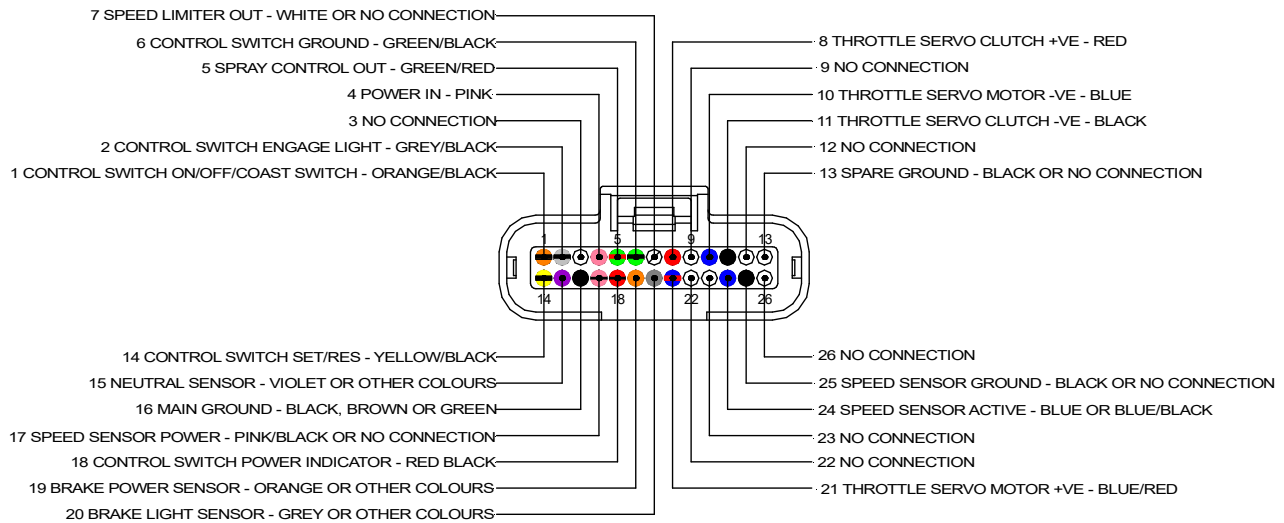



QUAD CRUISE

**ATV Electronic Cruise Control
with Spray/Accessory Control**

**Information, Set up & Operation Manual ©
(Sections 1~5 & 8~12)**

Refer to the Installation Manual for Sections 6 & 7

23 August 2024

MOTORCYCLE CRUISE CONTROLS

**MotorCycle Setup Pty. Ltd.
A.B.N. 94 798 167 654
AUSTRALIA**

WARNING

Your new QuadCruise has been designed to provide smooth, low-speed control over flat ground, ploughed fields and rough terrain - uphill and down dale.

The slow speed, however, can be deceiving!

The cruise control does NOT alter the inherent stability or centre of gravity of the ATV/RTV in any way. It is VITAL that you always follow the load restrictions advertised by the manufacturer and drive your ATV/RTV in a safe and responsible manner. Please take into consideration the slope of the ground and the total mass and distribution of any load when using your ATV/RTV - with or without the cruise control.

If the front of your ATV should ever start to lift off the ground, quickly and firmly press the rear brake pedal. If the cruise control is on, this single action will shut down power and immediately tend to thrust the front of the vehicle down onto the ground again. If you are under manual control, close the throttle as well as pressing the brake lever.

Your safety is at stake - please heed these warnings.

Electronic Cruise Control Information, Set up & Operation Manual ©

READ THIS FIRST

The cruise control computer used has been purpose built for ATV & motorcycle applications. Testing has resulted in programming to deliver safe, reliable operation on a variety of ATV's and motorcycles. It is essential that you install the cruise control precisely in accordance with the advice in the installation instructions precisely so that electrical interference does not cause the unit to behave erratically or be rendered inoperative.

We strongly recommend against fitting off-the-shelf motor car cruise controls to any ATV or motorcycle!

WARNING: - This cruise will function properly only if your vehicle has resistor type (radio suppression) ignition wires (spark plug leads). The cruise control may not function properly if aftermarket SOLID CORE spark plug wires are installed. Please read Section 11, Safety Issues & Features before fitting & using the cruise control.

If, after reading these instructions, you feel you are not competent to install this kit, we strongly urge you to seek the assistance of one of our authorised dealers and installers. Please phone or e-mail us to obtain the name of your nearest outlet.

CONTENTS

- 1. INTRODUCTION**
 - 2. WARNINGS, CAUTIONS AND NOTES**
 - 3. TOOLS REQUIRED**
 - 4. PARTS LIST**
 - 5. OVERVIEW OF CRUISE CONTROL OPERATION**
Refer to the separate Installation Manual provided for your make and model of vehicle for chapters 6 and 7.
 - 6. PREPARING THE VEHICLE FOR CRUISE CONTROL INSTALLATION**
 - 7. INSTALLATION**
 - 8. DIAGNOSTIC MODE OPERATION**
 - 9. CALIBRATION, ADJUSTMENTS & ROAD TEST**
 - 10. SAFETY ISSUES & FEATURES**
 - 11. TROUBLE SHOOTING**
- WARRANTY SHEET**
SET UP & CALIBRATION PROCEDURES SUMMARY SHEETS AND MENU MAP (LAST PAGES)

1. INTRODUCTION

Congratulations, you have purchased one of the most advanced cruise control systems in the world - and one that is built specifically for ATV's & motorcycles. All functions are microprocessor controlled, which reduces the complexity of installation. There are a number of additional features not found in other cruise controls. Please see part 15, Cruise control additional features, of this manual for more details.

Before installing your cruise control, take the time to read and understand each step in this manual. Several steps are dependent on others, so it is important know where and how each component is to be mounted before installation commences.

This manual covers the cruise control in general terms, and provides information about set up, calibration and adjustment of the cruise control. You will also find a separate installation instruction set that covers fitting the cruise control to your specific model of vehicle.

2. WARNINGS, CAUTIONS and NOTES

This manual contains several **cautions**, **warnings** and **notes**, which are prominently displayed. The convention used is:

A **warning** applies whenever injury could result from ignoring the warning;

A **caution** applies whenever damage to the vehicle or cruise control could result from ignoring the caution; and

A **note** applies where other aspects should be considered before any action to do with installation is undertaken.

EXAMPLES:

WARNING: - Always ensure the vehicle is properly supported on the side or centre stand and cannot accidentally fall off either stand.

CAUTION: - Before drilling any holes, make sure there are no components that may be damaged on the other side of the surface being drilled. Double check for any wiring harness that might be easily damaged by a drill bit.

NOTE: - Lay the wiring harness in place and connect the components before cable tying the harness in place.

3. TOOLS REQUIRED

NOTE – not all of the tools listed will be required for your installation, but most will be necessary or very helpful to have at hand.

- Socket and/or spanner, hex key set and screwdriver set to suit your vehicle.
- Torx driver set on some non-Japanese makes;
- Jeweller's screwdriver set (terminal extraction tool for some installations)
- Electrical Multimeter, Voltmeter or 12V test light (to check for electrical connections).
- Long nose pliers.
- A good quality flat file (useful to install the control switch for some installations).
- A vice with soft jaws or a rag (useful to install the control switch for some installations).
- Side cutters (to cut cable ties).
- Loctite '243' medium strength thread locking compound or equivalent.
- Electric drill (for some installations only);

- 6mm~6.5mm (15/64”~1/4”) drill bit (for some installations only);
- 38mm (1 1/2”) hole saw (for some installations only, where the wiring harness is fitted with a grommet);
- A sharp kitchen straight edge carving knife or similar (this is to cut the foam computer mount block on some applications. ‘Stanley’ or other types of utility knives DO NOT cut foam well).

The following tools are required for the installation on some cruise control kits, mostly non-Japanese models. These tools are not usually required for Japanese makes.

- Hot air gun (to shrink heat shrink tube where required). We DON’T recommend the use of cigarette lighters!
- Electrical terminal ‘roll’ crimpers (to crimp electrical terminals supplied in the kit) Utilux No 61 and No 47A or No 147A crimpers will cover almost all ATV & motorcycle terminals in the known universe!
- Soldering iron and electrical solder (where crimpers are not available or not useable).
- Roll of insulation tape.

4. PARTS LIST

Check that all components depicted on the first pages of the separate **INSTALLATION MANUAL** are included in the cruise control kit. Please phone (03) 9808 2804 within Australia, international (61 3) 9808 2804 or e-mail sales@mccruise.com for advice, if any parts are missing;

5. OVERVIEW OF CRUISE CONTROL OPERATION

Cruise control function

The principles behind your cruise control's operation are very simple:

- The computer continuously monitors the frequency of electrical pulses generated by the vehicles speedometer sender or by a speed sensor supplied in the cruise control kit;
- When the SET key on the switch is pressed, the computer stores the pulse frequency at the time in memory and then continuously adjusts the throttle servo, which controls the throttle to maintain the pulse frequency at the same figure to which it was set. If the frequency drops below the set frequency, the computer applies more throttle. If the frequency is above the set frequency, the computer releases the throttle. The key is that the computer monitors and reacts to changes very quickly and smoothly so that the speed effectively remains nearly constant.

There are several major components in most installations: the computer, the throttle servo, the cable interface unit OR a linkage arrangement to connect to the vehicle’s carburettor or throttle body, the speed sensor, the switch and the wiring harness. The functions of each are described below:

- The computer – monitors ground speed, adjusts the throttle by controlling the throttle servo, monitors, clutch and/or neutral detection, the brake system and the control switch for instructions from these components. In some installations engine rpm may be monitored as well;
 - The electric throttle servo - controls the throttle by pulling or releasing a cable which attaches to the throttle via the cable interface unit OR a special linkage provided in the kit;
 - The Cable Interface Unit (CIU) - translates the motion from the throttle trigger, grip or pedal and the electric throttle servo to the throttle via a new cable supplied in the kit – most, but not all, installations use the CIU.
- OR

The throttle linkage – allow safe operation of the normal throttle and control of the throttle by the cruise control;

- The speed sensor - generates electrical pulses when the vehicle is in motion. In many installations the vehicle's speedometer sender is used, in some a speed sensor is provided in the kit;
- The control switch - sends instructions from the operator to the computer; and
- The electrical wiring harness - which connects the switch, the computer, the throttle servo, the sensor, the brake system, the clutch and or the ignition system.

When the cruise control is operating, the throttle servo pulls directly on the carburetors or fuel injection throttle either via the Cable Interface Unit or via a direct linkage.

If the throttle trigger/twist grip/pedal is operated to open the throttle while the cruise control is engaged the operator over-rides the cruise control. When the throttle is released, the cruise control will resume control, unless it has been disengaged by brake operation or if the vehicle exceeds the current set speed by 200% or if the acceleration exceeds the pre-set limits in the cruise control. The cruise will also disengage if the speed drops to 50% of set speed such as when driving up a speed hill. The cruise control will also disengage if the speed goes above the maximum speed or drops below the minimum speed.

6. PREPARING THE VEHICLE FOR CRUISE CONTROL INSTALLATION

Refer to the separate installation instructions provided for your make and model of vehicle.

Specific instructions for this will be provided in your 'model specific' parts kit.

Lubricating the throttle cable and throttle mechanism.

NOTE: - this is essential maintenance to ensure smooth operation of the cruise control and throttle trigger/twist grip/pedal.

- Disconnect the throttle cable from the throttle trigger/twist grip/pedal.
- Run several drops of light oil (the sewing machine oil supplied in the kit is ideal – **DO NOT USE ENGINE OIL. It is too heavy!**) down the throttle cable/s.
- Re-assemble the twist grip/thumb throttle/cable/switch block assembly.
- Replace the handlebar end weight (if fitted). Use a medium strength thread lock compound on the threads of the bolt.

7. INSTALLATION

Refer to the separate Installation Manual provided for your make and model of vehicle.

8. DIAGNOSTIC MODE OPERATION

Note: - Refer to the cruise control Menu Map at the back of this manual to see the menu structure for the various functions available on this cruise control.

Diagnostic mode operation is used to confirm correct electrical and mechanical installation before actually driving the vehicle. During diagnostic mode operation the speed control programme is disabled, and correct operation of most parts of the cruise control can be checked in safety while the vehicle is stationary. Confirmation that electrical connections are correct is provided by the indicator light on the control switch and by the GREEN indicator light on the front of the computer (next to the loom plug).

MotorCycle Cruise Controls has three different control switches that can be supplied with the cruise control.

The earlier design has three large buttons and a small indicator light on the end of the switch next to the ON-OFF button. The buttons have text written on them for the functions. This switch will be phased out in late 2020.

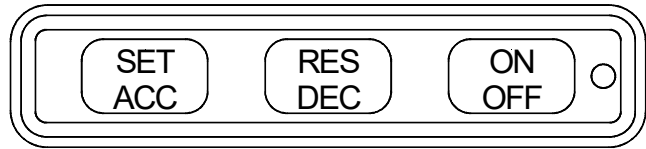

It will be replaced by this switch. The overall size of the switch is the same, it has the same mounting brackets and the same mounting holes. The text has been replaced by pictographs on the buttons. It is a direct replacement for the previous control switch shown above.

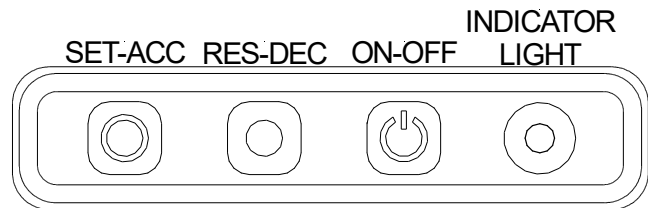

We also have another switch. This design has smaller buttons with no text, only pictographs on the buttons.

The ON-OFF button has a 'standard' power switch pictograph on it.

When it is mounted vertically on the handlebar, as shown here the orientation of the SET and RES buttons is as shown.

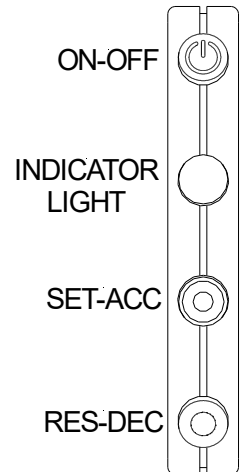

In some cases, this switch is also mounted below the bike's switch gear, and is mounted horizontally, the position of the SET and RES button are swapped.

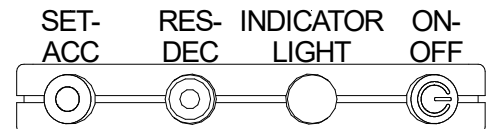

Note: - The control switch has an indicator light at the right end, next to the ON-OFF button. This light has three colours, RED and GREEN and AMBER. RED indicates power on. AMBER indicates cruise control engaged. GREEN is used to confirm the cruise control functions during the diagnostic checks and some calibration procedures.

There are also two lights on the cruise control computer. We have two different computers with the lights in different locations.

The computer with the aluminum box has two LED light on the front of the computer, one each side of the wiring harness connector. One is green, the other is red.

The computer that is in a translucent black plastic box had two lights inside the box. They are only visible when the lights are operating. The lights are visible from the sides of the box, near the connector end of the box.

During the diagnostic checks many of the features of the cruise control are confirmed by the GREEN light on the CONTROL SWITCH and the GREEN light on the COMPUTER operating. For example, the lights confirm brake switch operation.

While in diagnostic mode, the RED light on the COMPUTER is used to confirm correct tach sensing connection.

During normal operation the RED light on the COMPUTER displays stop and fault codes and is only used to diagnose problems. The control switch can also display the stop codes. See your troubleshooting guide for more details on this function.

- Chock the vehicle's wheels to ensure it will not roll away and make sure it is in neutral.

NOTE: - Because the park brake on many of these vehicles is linked to the normal brake system and often operates the brake light switches, the park brake often cannot be used.

- Turn the ignition switch OFF
- Make sure that the engine kill switch is ON (engine RUN position).
- Press and hold the SET and ON-OFF buttons.
- Turn ON the ignition switch - DO NOT START the engine. **HOLD THE BUTTONS FOR 5 SECONDS or until you see the back lights behind the control switch buttons come on or the indicator light comes on green.** After 5 seconds (or the lights coming on) release the buttons.
- The cruise control is now in diagnostic mode. You may hear the throttle servo do its self-test on power up

NOTE: - The following pages explain a series of tests to be performed with the cruise control in Diagnostic Mode. If you turn the ignition switch OFF in between the tests, you will need to repeat the above procedure to re-enter diagnostic mode before performing the next test. If you do leave the ignition switch ON, the cruise control will stay in diagnostic mode.

- Check that the Neutral is selected. If not, select Neutral (the indicator light MAY come on green. Ignore it for the moment).

Testing the brake system

- Operate the rear brake pedal a few times. The indicator light on the cruise control switch should illuminate GREEN and the light on the computer should illuminate green when the pedal is depressed and go out when it is released. Adjust the rear brake light switch so that the light comes on just before the brakes start to operate. Note: - There may be a slight delay (~1 sec) before the light goes out when the brakes are released on some occasions. This is normal and is NOT a fault.

NOTE: - If the brake switch is already ON (it is adjusted so that the switch never turns OFF or the switch is stuck on), then the light on the control switch will NOT COME ON AT ALL. The brake light switch must be OFF before applying the brake in order for the control switch light to work. If you cannot get the light to come on, check that your brake lights are not permanently on, and that they do actually work with brake application. If they are stuck on, back off the brake switch adjuster to ensure that the switch DOES TURN OFF. If the brake light globe is blown the light will not come on. In many cases if you have fitted an LED brake light or a brake light flasher system, this will prevent the cruise control detecting brake signal. THE CRUISE CONTROL WILL NOT WORK UNTIL THESE PROBLEMS ARE CORRECTED.

- Operate the front brake lever and the rear brake pedal a few times. The light on the switch should illuminate green when the brakes are used. This indicates that the cruise control will cancel when the brakes are applied.

NOTE: - If the vehicle is fitted with LED light globes or a flasher device on the brake light system this may cause interference with the cruise control brake detection. If the cruise control will not work, try replacing the brake light globes with standard globes and/or disconnecting the flasher device. Contact us for ways to enable both your brake light flasher and the cruise control.

Testing the control switch

- Depress the SET button. The switch light will go green and a noise may be heard from the throttle servo the FIRST time the button is pressed. This indicates that both the SET button and the throttle servo clutch are working correctly.
- Depress the RES button. The switch light will go green. This indicates that the RES button is working correctly.
- Press the ON-OFF switch. The switch light will go green when the button is pressed and go out when it is released. This indicates that the ON-OFF switch is working correctly.

Testing the throttle servo

- Apply the brakes (to ensure that the throttle servo is reset and the engine will idle), release the brakes and start the engine.

NOTE: - If the battery is not in good condition or is not fully charged, the cruise control computer may 'reset' when the engine is started (drop out of diagnostic mode) due to the drop in voltage when the starter motor is used. If this happens, the cruise control will no longer show any lights in response to button presses or brake application. In order to re-start the computer in diagnostic mode, press and hold the SET and ON-OFF buttons while you start the engine and HOLD the buttons for 5 seconds after the engine starts. When the battery voltage recovers after the engine is started, the computer will 're-boot' in diagnostic mode.

- Press the SET key several times until the engine revs start to increase. Each press will increase the speed slightly.

NOTE: - there will be some delay with this operation. It will take several presses (5~10) before the engine speed starts to increase. If the engine speed gets too high, the brake lever or the ignition switch will disengage the throttle servo. The engine kill switch will turn the engine off BUT MAY NOT RELEASE THE THROTTLE as the throttle servo may still be engaged if the kill switch does

not remove power to the brake light system. OPERATE THE BRAKE LEVER TO TURN THE THROTTLE SERVO OFF AND RELEASE THE THROTTLE.

NOTE: - The ignition switch will turn the cruise control off. This will also release the cruise from diagnostic mode. You will need to press and hold the SET and ON-OFF buttons while turning the ignition switch back ON to place the cruise in diagnostic mode again. Depress the brake lever to reset the throttle servo before restarting the engine and repeating the previous step.

- Press the RES key several times and the engine should gradually return to idle.
- Operate the brakes to reset the throttle servo.

Testing tach (engine over rev) sensing

Note: - In most cases the tach sensor is NOT connected on ATVs and Tractors. This test is not required.

- Observe the RED light on the COMPUTER and rev the engine a few times using the throttle. The red light should be flashing regularly and the flash rate should vary with the engine revs. In most cases, with the engine idling the flash rate will be around 2 flashes per second, but this may be different for different models.

Testing the speed sensor

WARNING: - MAKE SURE THAT THE VEHICLE IS SECURE ON STANDS WITH WHEELS CLEAR OF THE GROUND OR CAN BE DRIVEN BEFORE PROCEEDING WITH THE NEXT STEP.

- Engage 1ST gear and GENTLY drive forward. Watch the indicator light on the switch. The light should flash as the computer detects the speed signal. The pulse rate will vary depending on the speed. The faster the speed, the faster the pulse rate from the light. The speed of the flash rate is set to the calibration of the speed signal. If the calibration is correct, the light will flash once for every wheel revolution (on for half a turn and off for half a turn). This equates typically to one flash per second at 8kph (5mph). This indicates that the computer is detecting the speed signal. The green indicator light on the computer will also flash. If the flash rate is correct the calibration will be correct.

Testing and configuring the neutral sensor (if connected)

NOTE: - Perform this test with the vehicle stopped, and if gear selection can be done with the engine stopped, also with the engine stopped (not running).

NOTE: - The polarity (12V or 0V) of the clutch sensor is configurable. This section is to configure and test this feature.

- Make sure that the cruise control is in diagnostic mode. Press any of the buttons on the control switch. If the indicator light comes on green at each button press, the cruise control is in diagnostic mode. If the light does not come on green, turn the ignition switch off and re-enter diagnostic mode.
- Select Neutral with the gear shift. The indicator light on the switch may illuminate green when in Neutral and go out when in any other gear.

- If the light does come on **WHEN IN NEUTRAL, AND GOES OUT WHEN A GEAR IS SELECTED**, the test is complete. If it does not come on at all **OR** comes **ON WHEN A GEAR POSITION OTHER THAN NEUTRAL IS SELECTED**, move to the next step.
- Press and hold the ON-OFF button (light goes green) and then press the SET button and hold BOTH buttons until the light changes to RED (after about 5 seconds). After the indicator light on the switch changes from GREEN to RED release both buttons. This sets the neutral sensor to high (12V) detection.
- Shift gears in and out of Neutral.
- If the indicator light comes on green **WHEN IN NEUTRAL** and goes out when in another gear, the test is complete. If it does not, move to the next step.
- Press and hold the ON-OFF button (light goes green) and then press the RES button and hold BOTH buttons until the light changes to YELLOW (after about 5 seconds). After the indicator light on the switch changes from GREEN to YELLOW release both buttons. This sets the neutral sensor to low (0V) detection.
- Shift gears in and out of Neutral.
- If the indicator light comes on green **WHEN IN NEUTRAL** and goes out when in another gear, the test is complete. If it does not, move to the next step.
- If it does not come on at all you may have connected the neutral sensor wire to the wrong wire or the neutral switch may be faulty or it may be necessary to have the engine running during this test.

NOTE: - If the neutral switch is faulty or for any other reason you cannot get the switch to configure, it is likely that the clutch switch connection will prevent the cruise control from working. If you cannot configure the neutral sensing and the cruise control will not work, you may have to disconnect the neutral sensor wire from the neutral switch. Refer to the last page of the Trouble Shooting Guide, 'Diagnostic stop (error) codes'. If the cruise control will not engage due to a stop code 7 or 8 (neutral/clutch sensor fault), this indicates that the neutral switch cannot be configured, is configured incorrectly, is connected incorrectly or is faulty. You may have to disconnect the neutral sensor wire to enable the cruise control to operate, until the error can be corrected.

Checking the throttle servo cable free play.

Refer to the model specific installation instructions for details about this.

Re-assemble the vehicle for road testing

CAUTION: - Check that no wires and control cables are crushed or caught by any of the fairing panels, seat or the fuel tank during re-assembly. Check that all wires and cables are restrained and will not be damaged by any moving or stationary parts. Check that the seat will not damage the wiring harness or computer.

9. CALIBRATION, ADJUSTMENTS & ROAD TEST

NOTE: - There are several sheets at the end of this manual that can be removed and put in a pocket to assist with setup and calibration of the cruise control. One 'set' of sheets is the Menu Map showing the structure of the various menus that can be accessed to

configure the cruise control. The other ‘set’shows the various calibration procedures that can be performed and the order that they should be performed.

Since the brakes are the fastest way to turn the cruise control off, it is ESSENTIAL that they be adjusted optimally to suit the operator AND that they activate the brake lamp as quickly as possible. It is recommended that both front and rear brakes (where fitted) be set up so that the brake lamp turns on as early as possible when either brake is applied. Naturally you have to ensure that the brake lamp does turn off - otherwise the cruise control will not work at all. Careful adjustment of the foot brake lever so that the driver's foot does not have to lift up to reach it is recommended. Next, adjust the brake switch so that it turns on with very little movement of the brake pedal. Repeat this process with the front brake lever if adjustment is available.

WARNING: - If there is any evidence of inconsistent operation or sticking of either brake light switch, replace the switch. The brake light switches are the main components used to disengage the cruise control.

NOTE: - If the rear brake light filament or fuse breaks, or the brake light is on, the cruise control will not work at all. If your cruise control appears not to be working, these are the first things to

CALIBRATING AND ADJUSTING THE CRUISE CONTROL

NOTE: - In most cases, the computer will already be supplied configured for your vehicle. If this is the case, there will be a LABEL on the computer stating what MODEL it is configured for. This configuration is based on our tests with a similar vehicle to yours. You may be able to improve the performance of the cruise control by performing the calibration procedures, or the performance may be satisfactory as supplied.

NOTE: - IN MOST CASES THE COMPUTER IS SUPPLIED CONFIGURED FOR YOUR VEHICLE.

YOU CAN ROAD TEST IT NOW WITHOUT PERFORMING THE CALIBRATION PROCEDURES.

IF AFTER ROAD TESTING, YOU FEEL THAT THE PERFORMANCE COULD BE IMPROVED, YOU MAY PERFORM ANY OR ALL OF THE CALIBRATION PROCEDURES.

NOTE: - If the computer has a label on the side stating that it is ‘Not Configured’, you will have to complete the calibration and adjustment. The cruise control will NOT ENGAGE until you have completed ALL the calibration procedures.

NOTE: - The following pages discuss in detail the procedures required to calibrate the cruise control. There is also a single page sheet at the back of this manual that shows the steps required in brief. READ the procedure detail first, then use the single sheet as a memory jogger when out doing the calibration.

There are several steps that must be performed to ‘tune’ the cruise control to your vehicle. They are:

Speed sensor calibration.

This function teaches the cruise control computer how many pulses per wheel revolution it will receive from the speed sensor or the vehicle’s speedometer sender, so that the cruise control knows what speed the vehicle is

doing. This can be done while driving the vehicle at 10 kph (6 mph), OR by moving the vehicle over a 10 m (33 feet) distance.

Speed increment adjustment

This adjusts the speed increment on the SET/ACCElerate and RESume/DECelerate buttons when they are used to adjust the speed up or down. The default setting is 0.5kph (1/2 kph) per press of the buttons, so if, for example, you are ‘cruising’ at 10 kph, one press of the SET button will increase speed by 0.5 kph to 10.5 kph, and the RES button will decrease speed by 0.5 kph to 9.5 kph.

This function has several settings; #1 is 0.5 mph, #2 is 0.5 kph, #3 is 0.25 mph, #4 is 0.25 kph, #5 is 0.1mph, #6 is 0.1 kph, #7 is 0.05 mph, #8 is 0.05kph and #9 is 0.01kph. This is entirely for personal preference and has no effect on the performance of the cruise control. The default is #2 (0.5 kph). The other settings are mostly for use in research applications.

Initial throttle pull adjustment and calibration.

This function is only used to tell the cruise control how much throttle to apply when you first press SET or RES. The cruise control has a ‘map’ of throttle application versus speed curves and this must be set up or calibrated to suit your vehicle, so the correct amount of throttle is applied by the cruise control at all speeds. This function has NO EFFECT at all on how the cruise control works in controlling the speed after the first 1~2 seconds, it is ONLY to tell the cruise control how much throttle to apply when the cruise control is first engaged. This is very important to ensure the cruise engages smoothly without pushing (too much throttle) or lagging (not enough throttle).

This calibration procedure can take a while if it is a vehicle we have not tested before, and you have to start from scratch. The process to take is as follows.

- Initial selection of the Initial Throttle Pull Curve number. This function selects a mathematical curve of throttle application versus ground speed. We suggest an initial setting in order to speed up the adjustment process. This should be set to our recommended settings before you perform the other calibration procedures. Low numbers are used on powerful and throttle responsive vehicles, higher number on less powerful or less responsive vehicles. The range of numbers available starts at 1 and goes to 15.
- Calibrate the initial throttle pull. This function teaches the cruise control computer how much throttle to apply when you first engage the cruise control so that the speed does not ‘push’ or ‘lag’ when the cruise is first engaged. This is done while driving the vehicle at 5 to 8 kph (3~5 mph), and then the Curve you selected calculates the throttle pull required for speeds below and above 8 kph.

If you find that the cruise control engages well at one speed but does not apply enough throttle or applies too much throttle for higher or lower speeds after doing the single calibration (above) you can change the Initial Throttle Pull Curve number to improve the initial throttle pull across the speed range. Once you have selected the closest match available for your vehicle, if it is still not good at extremely low speeds below 5kph (3 mph) or at high speeds above 10kph (6mph), the initial throttle pull calibration can be done at two different speeds to further improve the way the cruise control engages across the range. The ‘low’ speed would normally be done at low speed of about 5~8 kph (3~5 mph) and the ‘high’ speed at 15 to 25 kph (10 to 15 mph). This will ‘customise’ the slope of the initial throttle pull curve to match the characteristics of the vehicle much more closely.

Operational Coarse Sensitivity or ‘Coarse Gain’ adjustment

This function is used to adjust how much the cruise control adjusts the throttle (apply more throttle or back off throttle) in response to speed variation (acceleration or deceleration) from the effects of wind or hills. This adjustment ONLY affects the operation of the cruise control AFTER the initial throttle application when the cruise control is controlling the vehicle's speed. It has NO EFFECT on the initial throttle application when the cruise control is first engaged. The process to take is as follows

Initial selection of the Sensitivity or 'Gain' number. Normally the gain number used would match the Initial Throttle Pull Curve number as a start point. After this is done, the vehicle must be driven to see how the cruise control behaves. If the number is too low, the speed will tend to wander and not control speed well, if it is too high, the cruise may be rough or tend to hunt (continuously apply and back off the throttle). The range of numbers available starts at 1 and goes to 15, a low number would be used on very responsive or powerful vehicles, a high number would be used on less responsive or less powerful vehicles. Note that a vehicle being responsive does not necessarily mean it is powerful, it is just very responsive to small throttle movements. Some quite powerful vehicles are not very throttle sensitive and vice-versa. This number can in particular be used to control how well the cruise control works in transitions to uphill or downhill situations, but must also work in steady state flat road situations.

NOTE: - This adjustment should be done if possible on the type of terrain the cruise control will working in. For example if the testing and adjustment is done on hard packed ground or a sealed surface, it may not be responsive enough if it is used on soft ground. If it is set up on soft ground, it may tend to 'hunt' on hard pack surfaces, particularly at low speeds and downhill.

Operational Fine Sensitivity or 'Fine Gain' adjustment

This function also is used to adjust how much the cruise control adjusts the throttle (apply more throttle or back off throttle) but has the most effect in controlling the cruise controls response around set speed. If you cannot find a setting on 'coarse' gain that holds speed well in transition to uphill or downhill that also stops the cruise control hunting or oscillation around set speed on flat going, this adjustment can help. This adjustment is mainly to allow the cruise control to 'settle' on speed without feeling like the cruise control is 'niggling' the throttle when on smooth surfaces. You can often achieve a smooth response in smooth flat running using the coarse gain, but sometimes the cruise becomes unresponsive in transitions to up or down hill. This adjustment can allow you to give good response in transitions with a relatively high coarse gain number, and then reduce the fine gain number to smooth the cruise control out in steady state (flat road) running.

The process to take is as follows:

Select a coarse gain number that gives good overall performance (see the previous section). This might still leave the cruise control feeling a little 'unsettled' in steady state smooth road situations. The fine gain default number is 5, the minimum is 1, the maximum is 10. Adjusting the fine gain modifies only one of the settings that the coarse gain adjusts (coarse gain changes many different settings). If the vehicle feels like the cruise is niggling at the throttle a lower number may help (speed control is quite good, but it never really feels 'smooth'). If the vehicle feels like the cruise is not really controlling the speed tightly (it just does not feel responsive), a higher number may help.

Acceleration Spread Gain adjustment

This adjusts how quickly and firmly the cruise control tries to get back to target speed if the speed varies. This is mainly a 'comfort' factor for the driver, but can also be used to improve performance of the cruise control on some vehicles.

This function has 5 settings and the default is the mid-point setting of 3. Changing this setting to 1 will make the cruise control very 'relaxed' in 'pushing' the vehicle back to set speed, changing this to 5 will make the

cruise quite aggressive in driving the vehicle back to set speed, however on some vehicles a high number may also induce 'hunting'. Note that this setting does not directly affect the speed holding of the cruise control, which is controlled by the 'Gain' setting above, but it will change how aggressive the cruise control is in pushing the vehicle back to set speed.

The three previous adjustments (Coarse Gain, Fine Gain and Acceleration Spread) are all available from within one 'Gain Adjustment' procedure. It is not necessary to stop the vehicle and turn the ignition off and back on to make changes to these three settings, they are all easily accessible without stopping the vehicle and all can be adjusted 'live' with the cruise control engaged so you can 'feel' the result of a change instantly.

There is also a 'Normal Operation Mode' after the Acceleration Spread Adjustment. This allows you to test the cruise control with all controls and lights operating normally without having to stop the vehicle and turning the ignition switch off. The order of these modes is, Coarse Gain, Fine Gain, Acceleration Spread, Normal Operation, then it returns to Coarse Gain etc. You can keep rotating through these functions, make adjustments, test etc for as long as you wish.

How to perform the calibration procedures

NOTE: - You will need a section of ground that is relatively flat (no hills) on which you can safely drive at 10kph (6mph) to perform the speed sensor and initial throttle pull calibrations. In order to perform the initial throttle pull calibration you need to be able to engage the cruise control continuously on flat ground for 5 seconds at a time. You will probably need to do this at least 3 times and maybe up to 10 or 15 times to get a good result. We use a flat section of dirt road in an orchard.

Speed Sensor Pulse Rate Calibration

- Turn the ignition switch OFF. Press and HOLD the RES and ON-OFF buttons, turn the ignition switch ON, **HOLD THE BUTTONS UNTIL THE SWITCH INDICATOR LIGHT COMES ON GREEN (a few seconds), then release the buttons.** The cruise control is now in speed pulse rate calibration mode.

10kph (6mph) calibration.

- Drive the vehicle at 10 kph (6 mph) and hold the speed STEADY. The GREEN indicator light will be flashing as you drive. The flash rate will vary with speed and the frequency of the pulses coming from the speed sensor, so the flash rate may be very slow or very fast or anywhere in between, in some cases it may be so fast you cannot see the flashing except at low speeds.
- Press and release the SET button once. The indicator on the switch will change to RED for two seconds and may flash yellow during this time. The computer will record the pulse rate of the speed signal. Hold the speed STEADY at 10 kph (6mph) for two seconds until the red light goes out. The light will resume flashing green from the speed signal after the red goes out.
- If you are not sure that your speed was correct or stable, adjust you speed to 10 kph (6 mph) again and simply press SET again. Each time SET is pressed the speed pulse rate will be recorded and saved overwriting the previous setting.
- Stop the vehicle and turn the ignition switch OFF, **DO NOT TURN THE IGNITION OFF BEFORE THE VEHICLE HAS STOPPED MOVING.** This completes the speed signal pulse rate calibration.

10 meter calibration.

- Mark out a 10 meter (~33 feet) length. Drive the vehicle to the start point. Line up some part of the vehicle with the start line.
- Press and release the SET button once.
- Drive slowly along the 10 meter distance (the speed is not critical) to the end point and stop when the same part of the vehicle is lined up with the end point. Do not back up if you overshoot the mark. As you drive, the green light will flash on and off. How fast the light flashes depends on the pulse rate from the speed sensor, it may flash very fast or slow. The light flashes once every 10 pulses from the speed sensor. When you reach the end point stop the vehicle and press and release the RES button once.
- If the calibration is acceptable, the light will come on green, if it is not the light will come on red and the previous calibration will be retained.
- If you are not sure that you started or stopped at the correct point, return to the start point and repeat the calibration procedure, press SET at the start and RES at the end.
- Stop the vehicle and turn the ignition switch OFF, **DO NOT TURN THE IGNITION OFF BEFORE THE VEHICLE HAS STOPPED MOVING.** This completes the speed signal pulse rate calibration.

Speed increment adjustment

- Turn the ignition switch OFF. Press and HOLD the RES and ON-OFF buttons, turn the ignition switch ON, **HOLD THE BUTTONS UNTIL THE SWITCH INDICATOR LIGHT COMES ON GREEN (a few seconds), then release the buttons.** The cruise control is now in speed pulse rate calibration mode.
- Press and HOLD the ON-OFF button. The indicator light will start flashing green. It will normally flash a number of times to display the setting (twice for setting #2) then pause for a couple of seconds, then flash the number again.
- While HOLDING the ON-OFF button, press SET to increase the number, press RES to decrease the number. #1 is 0.5 mph, #2 is 0.5 kph, #3 is 0.25 mph, #4 is 0.25 kph, #5 is 0.1mph, #6 is 0.1 kph, #7 is 0.05 mph, #8 is 0.05kph and #9 is 0.01kph.
- Count the number of flashes to confirm your selection.
- Release the ON-OFF button when you are finished making this adjustment (the light will go back to green, no flashing), then turn the ignition switch OFF. This completes the speed increment adjustment.

Initial Throttle Pull Curve adjustment

- Turn the ignition switch OFF. Press and HOLD the SET button ONLY, turn the ignition switch ON, **HOLD THE SET BUTTON UNTIL THE SWITCH INDICATOR LIGHT COMES ON GREEN (a few seconds), then release the button.** The cruise control is now in initial throttle pull calibration mode.
- Press and HOLD the ON-OFF button. The indicator light will start flashing green about once per second. It will normally flash a number of times to display the setting (once for setting 1) then pause for a couple of seconds, then flash the number again. The default setting is 1 on a new un-configured cruise control computer. If it a cruise control for a particular vehicle, it could be anywhere from 1 to 15. On an un-configured cruise control (not for a particular vehicle) refer to the selection table at the back of this manual for a suggested start number. Powerful and responsive vehicles will use a lower number (eg 1 to 8), less

powerful and less responsive vehicles will use a higher number (8 to 15).

- At this time, the number to use is a 'best guess', testing will confirm the selection or you can change it as needed.

Initial Throttle Pull Calibration

- Turn the ignition switch OFF. Press and HOLD the SET button ONLY, turn the ignition switch ON, **HOLD THE SET BUTTON UNTIL THE SWITCH INDICATOR LIGHT COMES ON GREEN (a few seconds), then release the button.** The cruise control is now in initial throttle pull calibration mode.
- Drive the vehicle at 5 to 8 kph (3 to 5 mph) on flat ground (no hills) and hold the speed **STEADY**. The GREEN indicator light will be on steady as you drive the vehicle. **NOTE: - This function will NOT work above 8kph (5mph).**

NOTE: - In the next procedure, the cruise control will apply an amount of throttle when you press the SET button, and you have to release the throttle a bit to allow the cruise control to take over. It then monitors the vehicle speed for 5 seconds, and depending on the change in speed, it makes a change to the initial throttle pull setting. If you completely release the throttle during this procedure, because the vehicle is travelling slowly, the vehicle will probably slow dramatically, and possibly stop altogether. You need to stop this happening, so when you press the SET button, release the throttle slightly so the vehicle slows down gently. This will allow the cruise control to 'calibrate' in a controlled manner.

- Press and release the SET button THEN release the throttle slightly, don't release it completely, a fraction of a second (about ½ a second is ideal) AFTER pressing the SET button. The computer will apply a small amount of throttle and the GREEN light on the switch will go out. The vehicle may hold speed, decelerate or accelerate depending on how responsive to throttle and how powerful the vehicle is. **DO NOT MOVE THE THROTTLE OR APPLY BRAKES TO STOP EITHER ACCELERATION OR DECELERATION.** Let the vehicle slow down or speed up without moving the throttle OR applying brakes.

NOTE: - You may apply the brakes BEFORE the 5 seconds are up (if you are blocked by another vehicle for example). This will cancel the calibration, and the result will NOT be recorded.

- After 5 seconds the green light will come back on and the cruise control will release the throttle (you may or may not feel this at all).
- Manually apply throttle to move the speed back to 8kph (5mph) and hold it **STEADY**.
- Press and release the SET button and then back off the throttle slightly again. The vehicle's acceleration or deceleration should be less than before, however it may take up to 10 times before this has any effect depending on vehicle power and throttle response.
- Wait 5 seconds for the light to come back on and the throttle to be released then drive back to 8kph again.
- After performing this routine several times, the vehicle's speed should hold fairly stable for 5 seconds at 8kph after you have pressed SET. This can take quite a few attempts to get right. Very powerful vehicles may take a few attempts to get a consistent result. Note that the cruise control will not attempt to adjust the throttle position during the 5 seconds, it will ONLY hold the throttle position steady and after the 5 seconds have lapsed, the throttle will be released.

HINT: - If you are having difficulty getting a consistent result, check that you are holding the speed very steady with the throttle just before pressing the SET button, and that you are not releasing the throttle before the cruise control has applied throttle. You MUST wait at least ½ second after pressing SET before you release

the throttle. If the transition from **YOU** holding the throttle to the **CRUISE CONTROL** holding the throttle is not seamless, the calibration may not work **accurately**. This effect will be much more pronounced on very powerful vehicles.

NOTE: - You can repeat this procedure as many times as you want and at any time you want to re-calibrate the initial throttle pull. If you have changed the loads on the vehicle (pulling a trailer for example) you may want to re-calibrate the initial throttle pull to compensate.

- Once you are happy that the amount of throttle applied is correct to maintain the speed, stop the vehicle and turn the ignition switch OFF, **DO NOT TURN THE IGNITION OFF BEFORE THE VEHICLE HAS STOPPED MOVING**. This completes the basic initial throttle pull calibration.

Initial Throttle Pull curve testing and fine tuning the slope of the curve

Testing for the correct 'initial pull curve' requires driving the vehicle at various speeds to see how the initial throttle pull performs. It should now be correct at 8kph (5mph) because you performed the calibration at that speed, however if the curve selected does not suit the vehicle, the initial throttle pull may not be correct at higher or lower speeds. Testing and adjustment for this can be done now or later at any time.

- Put the cruise control in normal operating mode (just turn the ignition on without holding any buttons). Turn the cruise control on (press the ON-OFF button so the red indicator light comes on).
- Apply and release the brakes (the cruise control will not engage until it has received a signal from the brake detection circuit).
- Drive the vehicle and engage the cruise control at various speeds, ranging from the lowest speed you expect to use the cruise (minimum allowable speed is 2.5 kph or approx. 1.5 mph) and up the highest speed you expect to use the cruise (maximum allowable speed is 25 kph or approx. 15 mph).
- Observe what happens at different speeds when you first engage the cruise control. Does the vehicle's speed drop when you first engage the cruise control, does it increase, or is the speed held steady? We are **ONLY** looking at what happens in the first 1 to 3 seconds **AFTER** you press the SET button.
- If the speed increases (pushes) when you engage the cruise at low speeds, and decreases (lags) at high speeds, then the initial pull curve number is too low. Enter initial pull calibrate mode, increase the number, and perform an initial pull calibration at 8kph (5 mph).
- If the speed decreases (lags) when you engage the cruise at low speeds, and increases (pushes) at high speeds, then the initial pull curve number is too high. Enter initial pull calibrate mode, decrease the number, and perform an initial pull calibration at 8kph (5 mph)
- If the push and lag is small (less than 0.5 kph speed change) then you will only need to change the curve number by 1 or 2, if the push or lag is quite pronounced (2kph speed change or more) you can change the number by 2, 3 or 4 numbers at a time. Change the curve number based on your tests.
- Put the cruise control in normal operating mode (just turn the ignition on without holding any buttons) and test the cruise again at various speeds to see if the curve selected is correct. This is an iterative process and it may take a few tries to get to the best result.
- Once you get a good result from the correct initial pull curve number, if you find that you cannot find a curve number to get really good performance across the entire speed range you wish to cover, you can then perform the initial pull calibration procedure at two different speeds to really fine tune your cruise control. The low speed initial pull calibration **MUST** be done at a speed lower than 8 kph (5mph), we suggest

between 5 and 8kph (3~5mph). The high speed initial pull calibration **MUST** be done at a speed higher than 10 kph (6mph). We suggest 15 to 25kph (10 to 15 mph).

- The cruise control will now use your two reference speeds (low and high) and the shape of the curve to calculate the initial pull at all speeds, instead of just one reference speed and the curve.

HINT: - If, after using the cruise control, you feel that the initial throttle pull is too light or too strong for your personal taste, you can ‘trick’ the cruise control by performing the initial throttle pull calibration on **slight** hills. If you want a GENTLER throttle application, calibrate the cruise control initial throttle pull on a **slight** DOWN hill. If you want a STRONGER throttle application calibrate the cruise control initial throttle pull on a **slight** UP hill.

Initial ‘Coarse Gain’ or ‘Coarse Sensitivity’ Adjustment

The ‘coarse gain’ or coarse sensitivity adjustment has 15 settings and the cruise control uses the indicator light on the switch to ‘flash’ this number, 1 through to 15. It will flash YELLOW the number of times corresponding to the Coarse Gain number, pause for a few seconds and then flash the number again.

Generally as a start point, the Gain number will be set to the same number as the Initial Pull Curve number. This usually gives a good starting point, and often will not need to be changed.

- Turn the ignition switch OFF. Press and HOLD the RES button ONLY, turn the ignition switch ON, **HOLD THE RES BUTTON UNTIL THE SWITCH INDICATOR LIGHT STARTS FLASHING RED/GREEN or YELLOW, then release the button. Apply and release the brakes, the light should now flash YELLOW.** The cruise control is now in gain adjustment mode.
- The indicator light will flash yellow about 1 flash per second, then pause for a few seconds and flash the number again. The gain number should be 1 on a new computer, unless the computer is pre-configured for a specific model.
- Either set the Gain number to the same setting as the Initial Pull Curve selected earlier, or refer to the Cruise Control Model Sensitivity list supplied with the cruise control and select an appropriate gain/sensitivity number for your vehicle.
- Press the SET button to increase the number or press the RES button to reduce number. Each press will change the number by one. Count the yellow flashes to confirm the setting.
- Turn the ignition switch OFF. This completes the initial ‘coarse gain’ or coarse sensitivity adjustment.

Testing and adjusting the gain setting (coarse gain, fine gain, acceleration spread and normal operating mode).

The three gain settings can be accessed within one adjustment ‘menu’. There is also a ‘normal operating’ mode after these three adjustments where you can use the cruise control normally without having to get out of the gain adjustment mode (having to stop the vehicle and turn the ignition off).

- To enter gain change mode, turn the ignition switch OFF. Press and HOLD the RES button ONLY, turn the ignition switch ON, **HOLD THE RES BUTTON UNTIL THE SWITCH INDICATOR LIGHT STARTS FLASHING RED/GREEN or YELLOW, then release the button.**

- Apply and release the brakes. The indicator light will now be flashing yellow. The cruise control is now in gain/sensitivity adjustment mode, and is in Coarse Gain adjustment. The cruise is now in Coarse Gain adjustment mode and displays the gain number by flashing the YELLOW light on the control switch.

Testing and adjusting the Coarse Gain

- Drive the vehicle at various speeds and press SET to engage the cruise control. The RES button does not work to engage the cruise control in this mode. Use the brake to disengage the cruise control and drive to a different speed, then press SET to engage the cruise control again.
- The cruise control should control the speed smoothly and without too much ‘wander’ in the speed.
- If the cruise control is too abrupt or hunts (applies and releases the throttle continuously), reduce the gain number.
- If the speed wanders too much and the response from the cruise control is slow, increase the gain number.
- Press the SET button to increase the number or press the RES button to reduce number. Each press will change the number by one. **You can make these adjustments either while riding with the cruise control engaged or with the vehicle stopped.** If you are stationary, each press of SET or RES will adjust the sensitivity. If you are riding between 3 kph and 25 kph, the first press of the SET button will engage the cruise. The RES will not work until the cruise control is engaged while moving. After the cruise control is engaged, the SET and RES buttons will adjust the sensitivity. **The Gain Number cannot be changed while the vehicle is moving with the cruise control disengaged, it can ONLY be adjusted when stationary OR when moving with the cruise control engaged.**
- **The minimum setting for Coarse Gain is 1, the maximum setting is 15.**
- If you do not wish to adjust the Fine Gain or the Acceleration Spread, stop the vehicle (the vehicle must be stationary) and turn the ignition switch OFF, **DO NOT TURN THE IGNITION OFF BEFORE THE VEHICLE HAS STOPPED MOVING.**

HINT: - The cruise control may ‘hunt’ on down hill sections as the cruise control tries to balance throttle against speed, particularly on hard packed ground. This will be more pronounced at lower speeds where very small amounts of throttle movement can cause large changes in speed. This will apply particularly if the throttle is wound all the way off to idle position and then re-applied. You will need to balance the sensitivity number with the performance you want from the cruise control in different circumstances. It may take some time for you to become accustomed to the cruise control and achieve a final setting that you find suitable for all situations. Large changes in load (towing a trailer) may also require a change in the setting.

Testing and adjusting the fine gain

If the ignition is still on and the cruise control is in coarse gain adjustment mode:

- Press and hold the ON-OFF button for more than 2 seconds until the light changes from flashing yellow to flashing RED. Release the ON-OFF button. The cruise is now in Fine Gain adjustment mode and displays the gain number by flashing the RED light on the control switch.

If the ignition switch has been turned off:

- Turn the ignition switch OFF. Press and HOLD the RES button ONLY, turn the ignition switch ON, **HOLD THE RES BUTTON UNTIL THE SWITCH INDICATOR LIGHT STARTS FLASHING RED/GREEN or YELLOW, then release the button.**
- Apply and release the brakes (the cruise control will not engage until it has received a signal from the brake detection circuit. The indicator light will now be flashing yellow. The cruise control is now in Coarse Gain adjustment mode.
- Press and hold the ON-OFF button for more than 2 seconds until the light changes from flashing .yellow to flashing RED. Release the ON-OFF button. The cruise is now in Fine Gain adjustment mode and displays the gain number by flashing the RED light on the control switch.
- It will flash a number of times to displays the setting (once for setting 1) then pause for a couple of seconds, then flash the number again. The default setting is 5. The settings range from 1 to 10.
- Drive the vehicle at various speeds and press SET to engage the cruise control. The RES button does not work to engage the cruise control in this mode. Use the brake to disengage the cruise control and drive to a different speed, then press SET to engage the cruise control again.
- The cruise control should control the speed smoothly and without too much ‘wander’ in the speed.
- If the cruise control feels like it is ‘niggling’ at the throttle (it is holding speed well, but never seems to quite ‘settle’, try reducing the fine gain number (press RES to decrease the gain number).
- If the speed does not feels like it is ‘locked in’, increase the gain number (press Set to increase the gain number).
- Press the SET button to increase the number or press the RES button to reduce number. Each press will change the number by one. **You can make these adjustments either while riding with the cruise control engaged or with the vehicle stopped.** If you are stationary, each press of SET or RES will adjust the sensitivity. If you are riding between 5 kph and 25 kph, the first press of the SET button will engage the cruise. The RES will not work until the cruise control is engaged while moving. After the cruise control is engaged, the SET and RES buttons will adjust the sensitivity.
- **The minimum setting for Fine Gain is 1, the maximum setting is 10.**
- If you do not wish to adjust the Acceleration Spread or make another change to the Coarse Gain, stop the vehicle (the vehicle must be stationary) and turn the ignition switch OFF, **DO NOT TURN THE IGNITION OFF BEFORE THE VEHICLE HAS STOPPED MOVING.**

Changing the Acceleration Spread adjustment

The next adjustment available is the Acceleration Spread. This adjustment is independent of the gain, but can have an effect on what gain number can be used.

If the ignition is still on and the cruise control is in fine gain adjustment mode:

- Press and hold the ON-OFF button for more than 2 seconds until the light changes from flashing red to flashing GREEN. Release the ON-OFF button. The cruise is now in Acceleration Spread adjustment mode and displays the gain number by flashing the GREEN light on the control switch.

If the ignition switch has been turned off:

- Turn the ignition switch OFF. Press and HOLD the RES button ONLY, turn the ignition switch ON, **HOLD THE RES BUTTON UNTIL THE SWITCH INDICATOR LIGHT STARTS FLASHING RED/GREEN or YELLOW, then release the button.**
- Apply and release the brakes (the cruise control will not engage until it has received a signal from the brake detection circuit. The indicator light will now be flashing yellow. The cruise control is now in Coarse Gain adjustment mode.
- Press and hold the ON-OFF button for more than 2 seconds until the light changes from flashing yellow to flashing RED. Release the ON-OFF button. The cruise is now in Fine Gain adjustment mode and displays the gain number by flashing the RED light on the control switch.
- Press and hold the ON-OFF button for more than 2 seconds until the light changes from flashing red to flashing GREEN. Release the ON-OFF button. The cruise is now in Acceleration Spread adjustment mode and displays the gain number by flashing the GREEN light on the control switch. It will flash a number of times to displays the setting (once for setting 1) then pause for a couple of seconds, then flash the number again. The default setting is 3.
- The settings range from 1 to 5. 1 will be very soft and the cruise control will be very ‘relaxed’ about getting back to the set speed. 5 will be much more aggressive, and the cruise will attempt to get back to set speed quite quickly. If the vehicle tends to hunt with the gain number you feel is right, try reducing the acceleration spread number, this will often ‘cure’ a vehicle that is prone to hunting. Other than that, the acceleration spread is mostly a matter of what ‘feels’ comfortable to you.
- Drive the vehicle at various speeds and press SET to engage the cruise control. The RES button does not work to engage the cruise control in this mode. Use the brake to disengage the cruise control and drive to a different speed, then press SET to engage the cruise control again.
- Press the SET button to increase the number or press the RES button to reduce number. Each press will change the number by one. **You can make these adjustments either while riding with the cruise control engaged or with the vehicle stopped.** If you are stationary, each press of SET or RES will adjust the sensitivity. If you are riding between 35 kph and 180 kph, the first press of the SET button will engage the cruise. The RES will not work until the cruise control is engaged while moving. After the cruise control is engaged, the SET and RES buttons will adjust the gain.
- **The minimum setting for Acceleration Spread is 1, the maximum setting is 5.**
- If you do not wish to adjust make more adjustments to the Coarse Gain or Fine Gain, stop the vehicle (the vehicle must be stationary) and turn the ignition switch OFF. **DO NOT TURN THE IGNITION OFF BEFORE THE VEHICLE HAS STOPPED MOVING.**

Gain Adjustment Normal Operation mode.

The next mode available is the Gain Adjustment Normal Operation Mode. This allows you to road test the cruise control normally without leaving the gain adjustment mode.

If the ignition is still on and the cruise control is in acceleration spread adjustment mode:

- Press and hold the ON-OFF button for more than 2 seconds until the light changes from flashing green to on solid (not flashing). If you are riding and the cruise control is engaged, the light will be yellow, if the cruise control is disengaged the light will be red. Release the ON-OFF button. The cruise is now in Gain Adjustment Normal Operation mode and can be used normally, except that the ON-OFF button will not

disengage the cruise control if pressed.

- All normal functions of the cruise control, lights and buttons will work normally EXCEPT the ON-OFF button will not disengage the cruise control. This allows you to continue to make changes to any of the three settings and then test them without having to stop the vehicle or turn the ignition switch off.
- In order to ‘scroll’ through the three adjustments and test mode, press and hold the ON-OFF button for more than 2 seconds to change to the next adjustment. The cruise will always start in Coarse Gain (yellow flashing light), then Fine Gain (red flashing light) then Acceleration Spread (green flashing light), then Normal Operation Mode, then back to Coarse Gain (yellow) and so on.

Road testing the cruise control

Start the vehicle.

NOTE: - THE CRUISE CONTROL COMPUTER TAKES A FEW SECONDS (LESS THAN 5 SECONDS) TO ‘BOOT UP’. AVOID PRESSING ANY BUTTONS FOR THE FIRST FEW SECONDS AFTER TURING THE IGNITION SWITCH ON OR STARTING THE VEHICLE.

To turn your cruise control ON, press the ON-OFF button once. The indicator light will come on RED to indicate power is ON. To turn the cruise control OFF, press the ON-OFF button again. The red indicator light will go out. The light is reasonably bright, but will not be easily visible in full sunlight. ***The light may be flashing red/green if the brakes have not been applied.***

Apply the brakes at least once. The cruise control will not engage until it detects the brake have been applied.

When riding, pressing the SET or RES buttons will engage the cruise control and the indicator light will turn yellow.

If the vehicle’s ignition switch is turned OFF, the cruise control will turn OFF. When the vehicle is started again next time, the cruise control will be OFF and SET or RES will NOT work. Press the ON-OFF button to turn the cruise control back ON (red indicator light will come on) to enable the SET and RES buttons.

- Press the ON/OFF switch once to turn the cruise control ON (red light ON);
- ***Apply the brakes at least once if the light is flashing red/green, it will then change to red.***
- Drive the vehicle to 6~8kph (4~5mph) and press the SET key. The cruise control should engage and smoothly maintain speed;
- Depress one of the brake levers to disengage the cruise control;
- Use the throttle to accelerate the vehicle up to 15~20kph (10~12mph) and press the SET key. The cruise control should engage and smoothly maintain speed within 1kph (about 0.6mph);
- Press the SET key 6 times. The cruise control should smoothly increase the speed by about 3 kph (2mph) (if the default speed increment is still used, otherwise it should change speed according to the selected increment).
- Press the RES key 6 times. The cruise control should smoothly decrease the speed by about 3 kph (2mph) again depending on the speed increment selected.

- Apply the brakes and slow down to about 6 kph (4mph). Press the RES key once. The cruise control should engage and smoothly accelerate to the previous SET speed and maintain speed within 1kph (about 0.6mph).

This completes the testing & adjustment procedure.

10. SAFETY ISSUES & FEATURES

Electrical 'Noise'.

Noise is a broad term used to describe the electromagnetic radiation of energy. Noise is generated during rapid changes in voltage or current levels or by radio transmitters (ignition systems, alternators, mobile phones and other heavy current carrying wires). If noise gets coupled into the cruise control wiring harness it can create disturbances within the cruise control computer. The cruise control may drop out after engagement or not engage at all, but still pass all diagnostic tests.

The most likely causes of electrical noise interference on a vehicle with a petrol engine is faulty spark plug leads or fitment of non-suppressed spark plug leads, or the electrical system could be in poor repair due to age or lack of appropriate preventative maintenance.

WARNING: - It is ESSENTIAL that the spark plug leads are radio suppression type leads and that they are in good condition. Inspect the spark plug leads for any cracks, and replace if required. All original equipment high-tension ignition leads, in optimal condition, should be acceptable, but the cruise control MUST NOT BE USED IF AFTERMARKET, SOLID CORE HIGH TENSION LEADS ARE FITTED.

Ideally all cruise control wiring should be kept as far as possible from all high voltage and high current wiring. This is often difficult to achieve on an ATV due to space limitations, so it is important to FOLLOW THE WIRING HARNESS INSTALLATION INSTRUCTIONS CAREFULLY.

Make sure that the vehicle's battery and charging system are in good condition and the battery electrolyte levels are correct and the battery connections are clean and tight. The battery acts as an electrical 'buffer' and absorbs electrical spike energy and stabilises voltage in the electrical system.

CruiseSafe throttle servo cut off.

As an additional safety measure, MotorCycle Setup has developed a new component for use on motorcycle & ATV cruise controls; the CruiseSafe cut off.

The MotorCycle Setup 'CruiseSafe' *throttle servo cut off* cuts power to the cruise control throttle servo whenever the brake is applied. This innovative safety device built in to the MCS product range and demonstrates the company's dedication to building product to the highest possible levels of safety, quality and reliability.

The 'CruiseSafe' cut off is a simple 'switch' incorporated into the brake circuit so that when the brake light switch operates, power to the cruise control throttle servo is shut down.

WARNING: - In order to stop the vehicle in the event of cruise control electrical malfunction, simply pull on the brakes. This will remove power to the cruise control throttle servo after approx 1 second delay.

WARNING: - In the event of a major malfunction, the cruise control may re-apply the throttle when the brakes are released. If this occurs, disconnect the loom computer plug from the cruise control computer until the cause can be found and remedied.

WARNING: - Any erratic behaviour from the cruise control should be regarded as suspicious, if the cruise control disengages at random or it fails to engage without turning the ignition switch off and back on, the cruise control computer should be disconnected until the cause can be found and remedied.

The 'CruiseSafe' protects you against accidental damage to the wiring loom or any sort of electrical failure or interference in the cruise control electronics causing a malfunction, because whenever the brakes are applied, the cruise control throttle servo is disconnected from power.

Its operation is failsafe, which means that if you lose power to the brakes, the brake light globes blow, a wire becomes disconnected or the 'CruiseSafe' fails, the power to the cruise control throttle servo is disconnected. The ONLY electrical failure it cannot protect against is if the brake light switch/s fail. Then you must turn the cruise control and the vehicle OFF using the vehicle's engine kill switch or ignition switch to kill the engine.

MotorCycle Setup has chosen to use a mechanical switch instead of an electronic device, because electrical interference cannot hinder its operation.

Other safety features.

The cruise control can be shut off by any of the following methods:

- Applying the brakes;
- Pulling in the clutch (as long as clutch and/or tach sensing are connected);
- Pressing the ON/OFF button to OFF;
- Accelerating to 200% of the SET speed or exceeding the maximum speed;
- Decelerating to 50% of the SET speed or running under the minimum speed (2.5kph, 1.5mph);
- Turning the engine kill switch OFF (this stops the engine but may NOT turn off the cruise control);
- Turning off the ignition key.

The cruise control will disengage if any of the connectors become separated, if the brake light filament breaks or the brake light system loses power - for example if a fuse blows.

There are numerous safety features designed into the computer and throttle servo to ensure that should one or more components fail there is still a way to turn off your cruise control.

For safe riding NEVER operate this cruise control in heavy traffic conditions or on wet roads or other hazardous conditions.

WARNING: Your cruise control is designed with numerous safety features, but only the vehicles KILL SWITCH or the IGNITION KEY can overcome a runaway condition caused by a tangled or jammed carburettor linkage.

Regular inspection of control cables is recommended to prevent jamming of the throttle, which could occur if cables were frayed or damaged.

11. TROUBLE SHOOTING

A potential source of problems is electrical interference. Your kit has been developed based on testing to avoid this type of problem by installing the loom and computer in unaffected areas. However, as the speed rises the electrical fields generated by the vehicle increase. Also, older vehicles tend to produce larger electrical fields from old spark plug leads or coils. If you experience this type of problem, check that you have followed the installation instructions precisely. Correct any obvious mistakes. If the problem persists call MotorCycle Setup for advice. As a last resort, we will refer you to our local installer if you are prepared to pay for him to check the installation and follow his recommendations. If our dealer/installer network is unable to make the unit work properly, you will receive a full refund of the cost of the cruise control (NOT including freight) on return of the kit. If the cruise control was purchased through a dealer (or other third party) it must be returned via that third party.

There is a separate trouble-shooting guide supplied with the kit. Refer to the trouble-shooting guide for detailed problem diagnosis.

The most common cause of problems is intermittent/dirty electrical connections. Check the connections for continuity at all connection points. Perform a diagnostic mode check (see the trouble shooting guide or section 8 in this manual), as this will provide an indication of what components are not working correctly.

Refer to the Operation and User Manual for more information on operating the cruise control.

NOTES:

MOTORCYCLE SETUP PTY. LTD.

12 MONTH CONSUMER SATISFACTION GUARANTEE REGISTRATION

Please keep this card and your receipt in a safe place. Copies of both are required if warranty service is needed.

Name: _____

Address: _____

Telephone Number: _____

Item Model Number: _____ Date Purchased _____

Name of Retailer: _____

Installed By: _____

Year, Make and Model of Motorcycle: _____

I have read the warranty agreement below and accept its terms.

Customer signature: _____

Warranty service requires a copy of the sales receipt.

12 MONTH WARRANTY

MotorCycle Setup Pty. Ltd., Unit 13,137-145 Rooks Road, Nunawading, Victoria 3131, AUSTRALIA, hereby warrant that it will repair or replace to the original purchaser products which prove to be defective under normal use and service in workmanship or material.

MotorCycle Setup obligation under this warranty is limited to the repair or replacement of the product at its option without charge for parts and labour at its warehouse located at the above address at Mount Waverley, when the product is returned with postal charges prepaid and examination of the product shall disclose it not to have been defective in the respects aforesaid during the warranty period.

The repairs or replacements will be made promptly and the repaired unit will be returned with all postal charges prepaid.

Coverage under this warranty is limited to the original purchase of the product at retail. When requesting warranty service a copy of the sales receipt or guarantee card must be submitted.

The warranty period for cruise controls is limited to a period of 12 months from the date of purchase. No warranty is implied for the installation and therefore MotorCycle Setup will not be responsible for installation or re-installation charges.

This warranty does not apply to products or equipment or components used in conjunction with the cruise control.

Warranty does not cover unauthorised repairs, improper installation or application, damage or misuse or product which has not been maintained or used in accordance with the operating specifications as set forth in the written instructions.

The warranty term shall not extend beyond its original term with respect to subsequent warranty replacement.

Under no circumstances shall MotorCycle Setup be liable for consequential damages or breach of this warranty or for any implied warranty.

MotorCycle Setup neither assumes nor authorises any person to assume for it or any obligation or liability other than herein expressly stated.

MOTORCYCLE SETUP CUSTOMER SERVICE POLICY

You will receive free consultation on any problem you might encounter in the assembly or use of MotorCycle Setup products. Just drop us a note, e-mail us at sales@mccruise.com or give us a call on +61 3 9808 2804.

You can obtain parts directly from MotorCycle Setup by writing to us or from your dealer. Use your packing list to describe your requirements.

If you are not satisfied with our service or with our products, write direct to the Managing Director, MotorCycle Setup Pty. Ltd., Unit 13,137-145 Rooks Road, Nunawading, Victoria 3131, AUSTRALIA. He will make certain your problem receives immediate personal attention.

The benefits conferred by this guarantee are in addition to all other rights and remedies in respect of the product, which the consumer has under the Trade Practices Act, and other State and Territory Laws.

Set up & Calibration procedures (MUST be performed in the following order)

NOTE: - In most cases these procedures do NOT need to be performed, the cruise control is already pre-calibrated for the vehicle it is fitted to.

SET/RES button speed increment adjustment.

- Enter Speed Pulse Rate Calibration mode (RES and ON-OFF held, turn ignition ON and start engine, wait for light to come on green, release buttons).
- Press and HOLD the ON-OFF button (green light flashes to display current increment number)
- While holding the ON-OFF button, press SET to increase the increment number (higher number), press RES to decrease the increment number (lower number). Count green flashes to read number.
#1 = 0.5mph incr. #2 = 0.5kph incr. #3 = 0.25mph incr. #4 = 0.25kph incr. #5 = 0.1mph incr. #6 = 0.1kph incr. #7 = 0.05mph incr. #8 = 0.05kph incr. #9 = 0.01kph incr.
- Release ON-OFF button exit back to Speed Pulse Rate Calibration mode.
- Turn ignition OFF **OR** stay in mode for the next step.

Calibrate Speed Signal.

- Enter Speed Pulse Rate Calibration mode (RES and ON-OFF held, turn ignition ON and start engine, wait for light to come on green, release buttons).
10kph calibration.
- Drive to **steady** 10kph, (6mph). Green light flashing.
- Press SET, light goes red/yellow for 2 seconds.
- **Bring vehicle to a stop**, then turn ignition OFF to exit.

10 meter calibration

- Mark out 10m (33 ft) length
- Move to start mark, stop vehicle.
- Press SET.
- Drive to end mark (green light flashing), stop at end mark.
- Press RES. Green light comes on = calibration accepted, Red light comes on = calibration not accepted.

Initial Throttle Pull Curve selection

- Enter Initial Throttle Pull Calibration mode (SET held, turn ignition ON and start engine, wait for light to come on green, release button).
- Apply and release the brakes.
- Press and HOLD the ON-OFF button.
- While holding the ON-OFF button, press SET to increase the curve number (higher number), press RES to decrease the curve number (lower number). Count green flashes to read number (curve numbers are 1 thru 15).
- Release ON-OFF button to exit back to Initial Throttle Pull Calibrate mode.
- Turn ignition OFF **OR** stay in this mode for the next step.

Calibrate Initial Throttle Pull.

- Enter Initial Throttle Pull Calibrated mode (SET held, turn ignition ON and start engine, wait for light to come on green, release button).
- Apply and release the brakes.
- Drive to **steady** 5 to 8kph, (3 to 5mph) on **flat and level road**. Green light on solid (NOT flashing).
- Press SET, back off throttle slightly (don't release completely). Light goes OFF for 5 seconds.
- After 5 seconds cruise releases throttle and green light comes on.
- Repeat as necessary until vehicle maintains **steady and stable** 8kph (5mph) after SET is pressed.
- **Bring vehicle to a stop**, then turn ignition OFF to exit.

Note: - Initial throttle pull can also be performed at two different speed, low speed (4 to 8kph) and high speed (15 to 25kph).

Coarse Gain/Fine Gain/Acceleration Spread/Normal Operation Test Mode Setting.**Coarse Gain setting.**

- Enter Coarse Gain Adjustment mode (RES held, turn ignition switch ON, wait for light to flash red/green or yellow, release button).
- Apply and release brakes, light flashes yellow to display Coarse Gain number.
- Press SET to increase gain (higher number), press RES to decrease gain (lower number). Count yellow flashes to read number (gain numbers are 1 thru 15).
- Drive at various speeds, press SET to engage cruise control, then use SET and RES to increase and decrease Coarse Gain as needed **while cruise control is engaged**.
- Use brakes to disengage cruise control.
- Press SET to re-engage cruise control at different speeds and make adjustments to gain/sensitivity using SET and RES.
- Adjustments may also be made when stationary using SET and RES if desired.
- If desired, Fine Gain and Acceleration Spread may be adjusted next (see next section) **OR**
- **Bring vehicle to a stop, then** turn ignition OFF to exit.

Fine Gain setting.

Already in Coarse Gain setting (see above), yellow flashing light.

- Press and HOLD the ON-OFF button for more than 2 seconds until light flashes red to display Fine Gain number (default = 5).
- Press SET to increase gain (higher number), press RES to decrease gain (lower number). Count red flashes to read number (gain numbers are 1 thru 10).
- Drive at various speeds, press SET to engage cruise control, then use SET and RES to increase and decrease Fine Gain as needed **while cruise control is engaged**.
- Use brakes to disengage cruise control.
- Press SET to re-engage cruise control at different speeds and make adjustments to gain/sensitivity using SET and RES.
- Adjustments may also be made when stationary using SET and RES if desired.
- If desired, Acceleration Spread may be adjusted next (see next section) **OR**
- **Bring vehicle to a stop, then** turn ignition OFF to exit.

Acceleration Spread Setting.

Already in Fine Gain setting (see above), red flashing light.

- Press and HOLD the ON-OFF button for more than 2 seconds until light flashes green to display Acceleration Spread Gain number (default = 3).
- Press SET to increase the Accel Spread number (higher number = high accel), press RES to decrease the Accel Spread number (lower number = low accel). Count green flashes to read number (numbers are 1 thru 5).
- Drive at various speeds, press SET to engage cruise control, then use SET and RES to increase and decrease Acceleration Spread as needed **while cruise control is engaged**.
- Use brakes to disengage cruise control.
- Press SET to re-engage cruise control at different speeds and make adjustments to Acceleration Spread using SET and RES.
- Adjustments may also be made when stationary using SET and RES if desired.
- If desired, Coarse Gain may be adjusted next (see next section) **OR**
- **Bring vehicle to a stop, then** turn ignition OFF to exit.

Normal Operation Test Mode.

Already in Acceleration Spread setting (see above), green flashing light.

- Press and HOLD the ON-OFF button for more than 2 seconds until light changes to solid red (cruise not engaged) or solid yellow (cruise engaged). Buttons and lights operate normally.

Return to Coarse Gain Setting.

Already in Normal Operation Test Mode (see above), yellow or red solid light.

- Press and HOLD the ON-OFF button for more than 2 seconds until light flashes yellow to display Coarse Gain number.

Cruise Control Menu Map

Menus for normal operation

Normal cruise control operation

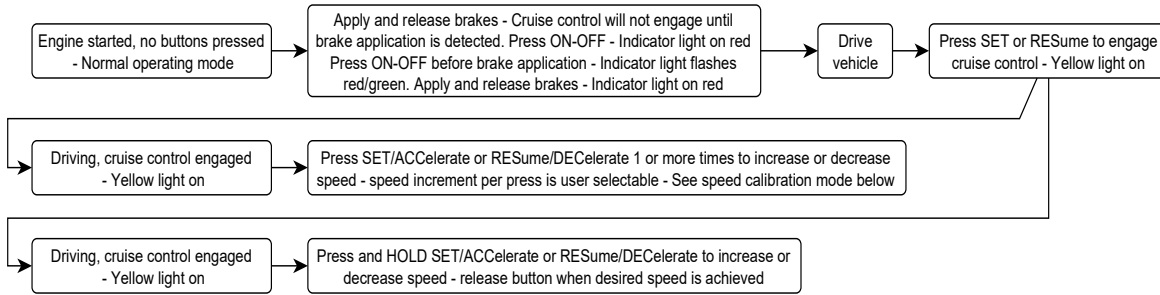

Normal cruise control operation - Lock SET speed

If a fixed speed is desired for spraying or similar operation, the SET speed can be locked to prevent accidental changes to SET speed.

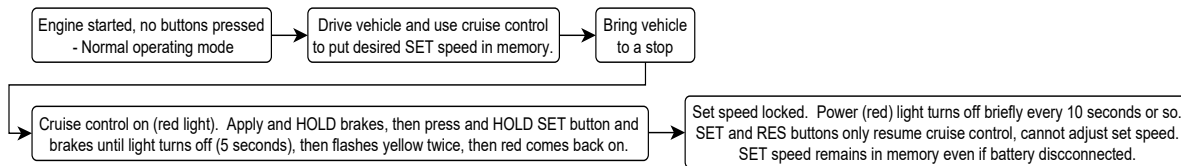

Normal cruise control operation - Unlock SET speed

Return to normal operation without locked SET speed.

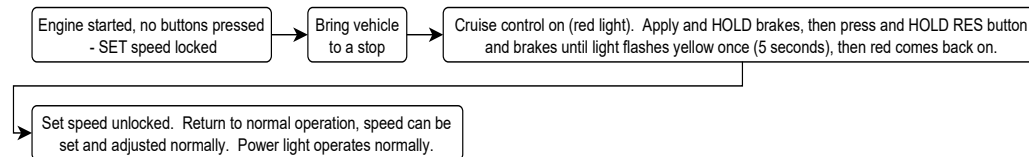

Access stop codes

This is used to diagnose why the cruise control disengages or will not engage

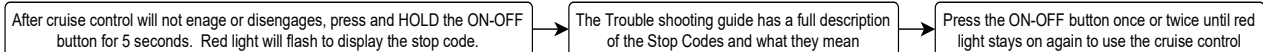

Menus for normal testing after installation.

Diagnostic mode

Test electrical and mechanical operation of cruise control
Setup clutch sensor and speed sensor configuration. Advanced throttle servo/actuator testing

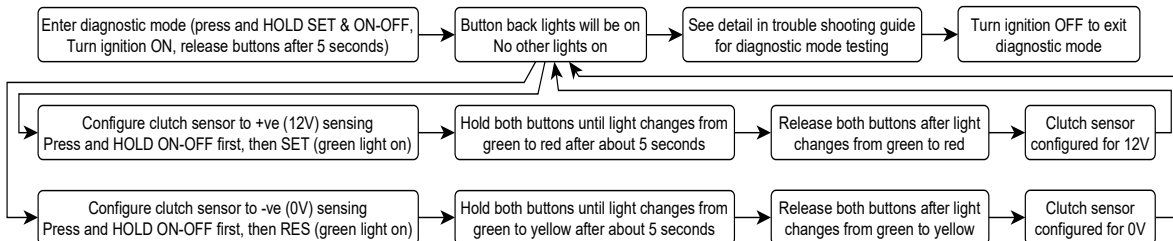

Menus for 'fine tuning' or adjusting the cruise control performance.

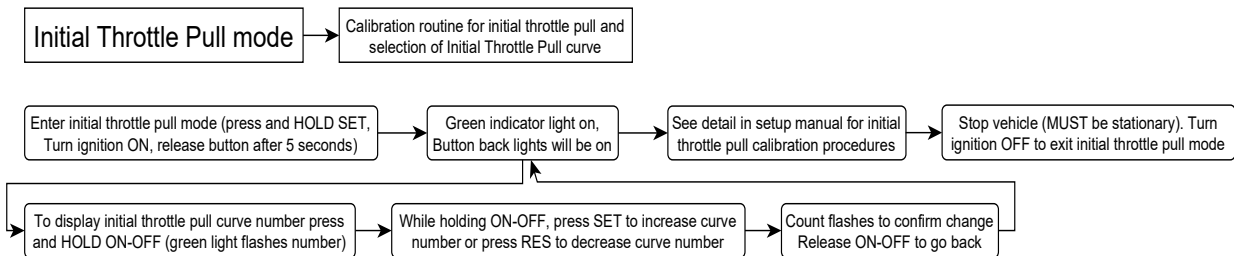
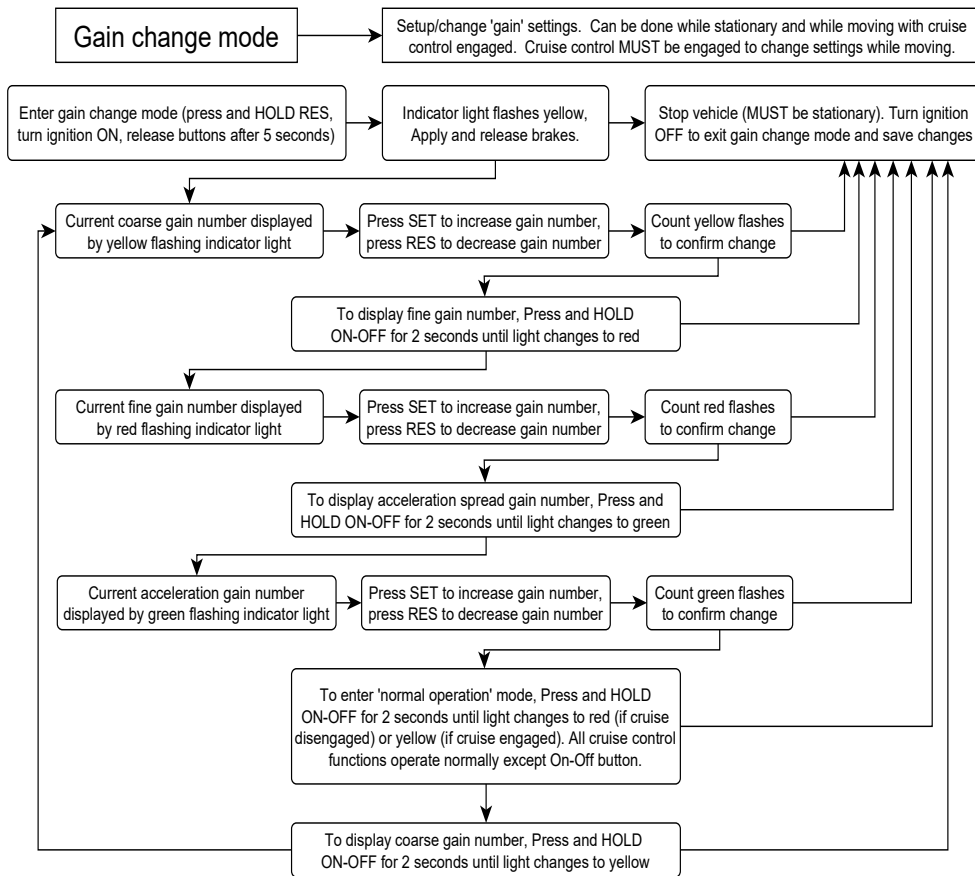

Menus for setting up the cruise control from 'scratch' (cruise control not pre-calibrated for the vehicle).

NOTE: - In most cases the cruise control is already calibrated to suit the vehicle and these procedures will not need to be performed.

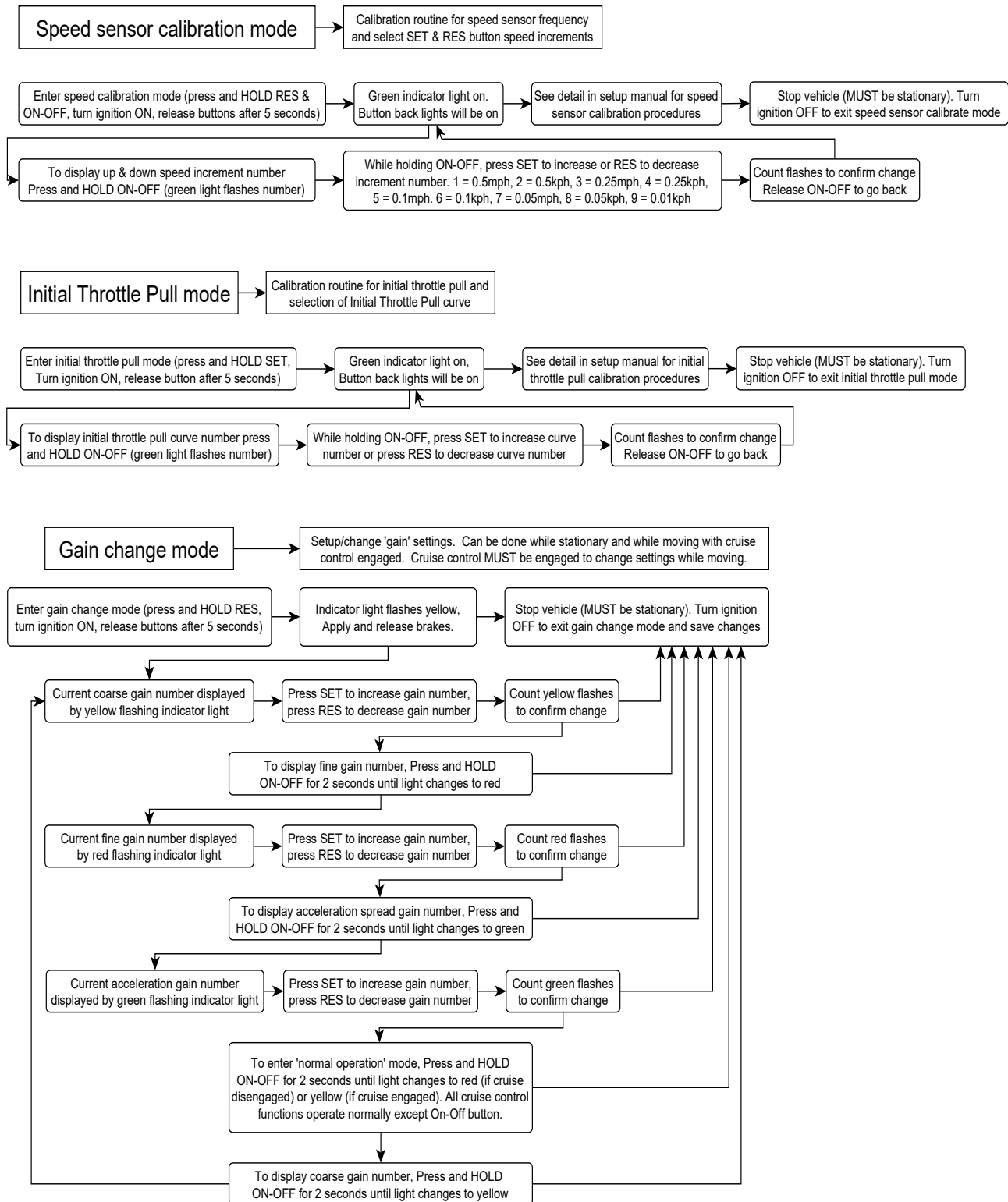

Menus for 'out of the ordinary' functions.

Speed sensor setup and throttle servo diagnostics.

